

0.5mm Pitch

SERIES

# 6809

004L-2009-0

0.5mmピッチ FPC/FFC コネクタ (切欠き付きFPC/FFCタイプ)  
0.5mmPitch, FPC/FFC Connector (For Notched FPC/FFC)

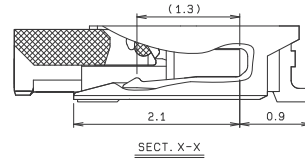
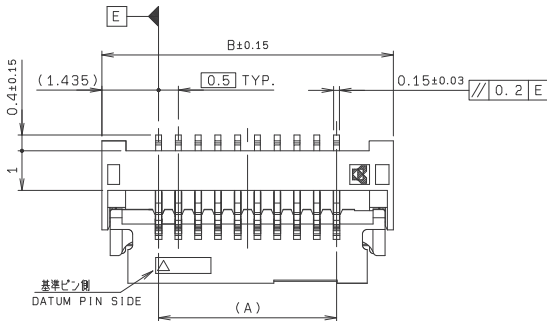

極数 NO. OF POS.	A	B	C	D	E	F
4	1.5	4.37	3.17	3.80	3.55	4.35
5	2.0	4.87	3.67	4.30	4.05	4.85
6	2.5	5.37	4.17	4.80	4.55	5.35
7	3.0	5.87	4.67	5.30	5.05	5.85
8	3.5	6.37	5.17	5.80	5.55	6.35
9	4.0	6.87	5.67	6.30	6.05	6.85
10	4.5	7.37	6.17	6.80	6.55	7.35
11	5.0	7.87	6.67	7.30	7.05	7.85
12	5.5	8.37	7.17	7.80	7.55	8.35
13	6.0	8.87	7.67	8.30	8.05	8.85
14	6.5	9.37	8.17	8.80	8.55	9.35
15	7.0	9.87	8.67	9.30	9.05	9.85
16	7.5	10.37	9.17	9.80	9.55	10.35
17	8.0	10.87	9.67	10.30	10.05	10.85
18	8.5	11.37	10.17	10.80	10.55	11.35
19	9.0	11.87	10.67	11.30	11.05	11.85
20	9.5	12.37	11.17	11.80	11.55	12.35
21	10.0	12.87	11.67	12.30	12.05	12.85
22	10.5	13.37	12.17	12.80	12.55	13.35
23	11.0	13.87	12.67	13.30	13.05	13.85
24	11.5	14.37	13.17	13.80	13.55	14.35
25	12.0	14.87	13.67	14.30	14.05	14.85
26	12.5	15.37	14.17	14.80	14.55	15.35
27	13.0	15.87	14.67	15.30	15.05	15.85
28	13.5	16.37	15.17	15.80	15.55	16.35
29	14.0	16.87	15.67	16.30	16.05	16.85
30	14.5	17.37	16.17	16.80	16.55	17.35
31	15.0	17.87	16.67	17.30	17.05	17.85
32	15.5	18.37	17.17	17.80	17.55	18.35
33	16.0	18.87	17.67	18.30	18.05	18.85
34	16.5	19.37	18.17	18.80	18.55	19.35
35	17.0	19.87	18.67	19.30	19.05	19.85
36	17.5	20.37	19.17	19.80	19.55	20.35
37	18.0	20.87	19.67	20.30	20.05	20.85
38	18.5	21.37	20.17	20.80	20.55	21.35
39	19.0	21.87	20.67	21.30	21.05	21.85
40	19.5	22.37	21.17	21.80	21.55	22.35

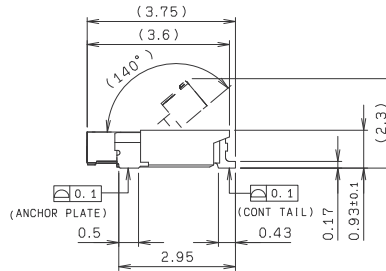
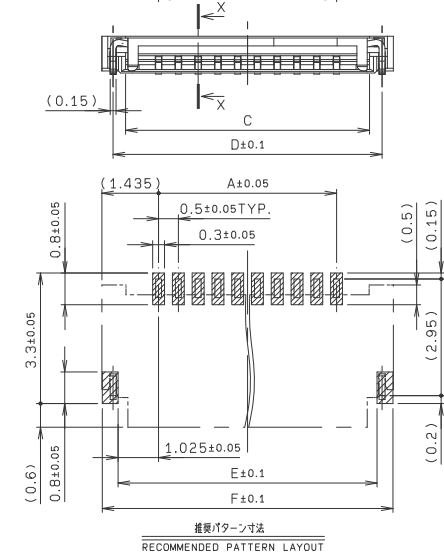

切欠き付きFPC/FFCタイプ  
For Notched FPC/FFC Cables

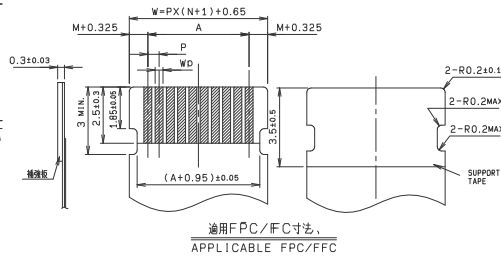

適用FPC/FFC寸法、  
APPLICABLE FPC/FFC

	FPC		FFC	
	1	2	1	2
M	0.5±0.12	0.5±0.1	0.5±0.1	0.5±0.08
P	0.5±0.02	0.5±0.05	0.5±0.03	0.5±0.05
A	A±0.03	A±0.05	A±0.03	A±0.05
W	W±0.07	W±0.07	W±0.07	W±0.07
Wp	0.35 <sup>+0.04</sup> <sub>-0.03</sub>	0.35±0.05	0.3 <sup>+0.05</sup> <sub>-0.02</sub>	0.3 <sup>+0.05</sup> <sub>-0.02</sub>

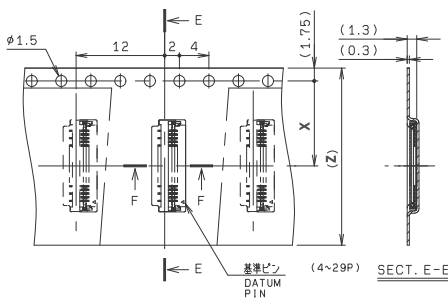

極数 NO. OF POS.	X	Y	Z
4-13	7.5	—	16.0
14-27	11.5	—	24.0
28-39	14.2	28.4	32.0
40	20.2	40.4	44.0

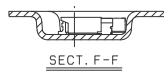

REEL DIMENSION

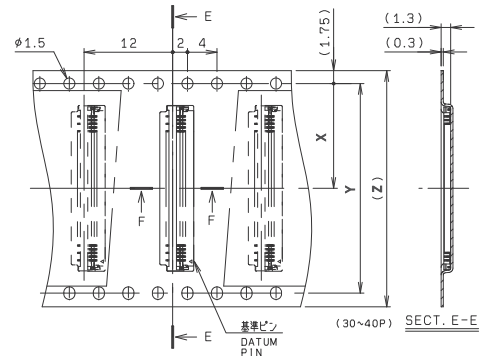

注文コード / Ordering Code

Part No. 04 6809 6XX X10 846+

極数 No. of Pos.

エンボステープ幅 (Z)  
EMBOSS TAPE WIDTH (Z)

梱包数量: 4,000個/リール  
PACKING QUANTITY: 4,000/Reel

1: 16mm (4-13P)  
2: 24mm (14-27P)  
3: 32mm (28-39P)  
4: 44mm (40P)

RoHS 対応品  
RoHS Compliant Product

生産対応可能極数については、営業部にご確認願います。  
Feel free to contact our sales department for available numbers of positions.



- このカタログの記載内容については予告なく変更することがありますので、ご了承ください。  
Specification of the catalogue might be changed without notice.
- 御使用の際は、納入仕様書を確認の上、正しくお使いください。  
Please verify our drawing and specification with your design.

