

SECTION X-X

- NOTE:
- MATERIAL:  
HOUSING: PA46 GLASS FILLED, UL94V-0, COLOR: NATURAL  
TERMINAL: PHOSPHOR BRONZE
  - PLATING: 1) PARTIAL GOLD PLATING OVER NICKEL PLATING OVERALL  
CONTACT POINT: 0.10µm MINIMUM GOLD PLATING  
TAIL POINT :GOLD PLATING  
2) 1-3 µm TIN-BISMUTH OVER NICKEL PLATING OVERALL
  - PRODUCT SPECIFICATION: PS-78119-001
  - PRODUCT ARE PACKED IN TAPE & REEL.

ASSY P/N PACKED IN T&R	ASSY P/N W/O PACKAGING	CKT	W	So	F	Bo	B	EMBOSSED TYPE
78119-1409	78119-0409	40	44.00	40.40	20.20	22.40	20.10	B

THIS DRAWING CONTAINS INFORMATION THAT IS PROPRIETARY TO MOLEX ELECTRONIC TECHNOLOGIES, LLC AND SHOULD NOT BE USED WITHOUT WRITTEN PERMISSION											
DIMENSION UNITS <b>mm</b>		SCALE <b>NTS</b>		CURRENT REV DESC: OBSOLETE PART NO						<b>molex</b>	
GENERAL TOLERANCES (UNLESS SPECIFIED)				EC NO: 629832							
ANGULAR TOL ± 3.0 °		4 PLACES ±		DRWN: PKH		2019/12/10		0.50MM PITCH, FPC CONN. NON-ZIF, SMT			
3 PLACES ±		APPR: GGA		2020/01/22							
2 PLACES ± 0.15		INITIAL REVISION:		PRODUCT CUSTOMER DRAWING							
1 PLACE ±		DRWN: YLQIAO		2006/04/11		DOCUMENT NUMBER		DOC TYPE		DOC PART	
0 PLACES ±		APPR: PTLIM		2006/04/18		SD-78119-001		PSD		001	
DRAFT WHERE APPLICABLE MUST REMAIN WITHIN DIMENSIONS		THIRD ANGLE PROJECTION		DRAWING		SERIES		MATERIAL NUMBER		CUSTOMER	
		A3-SIZE		78119		SEE TABLE		GENERAL MARKET		SHEET NUMBER 1 OF 5	

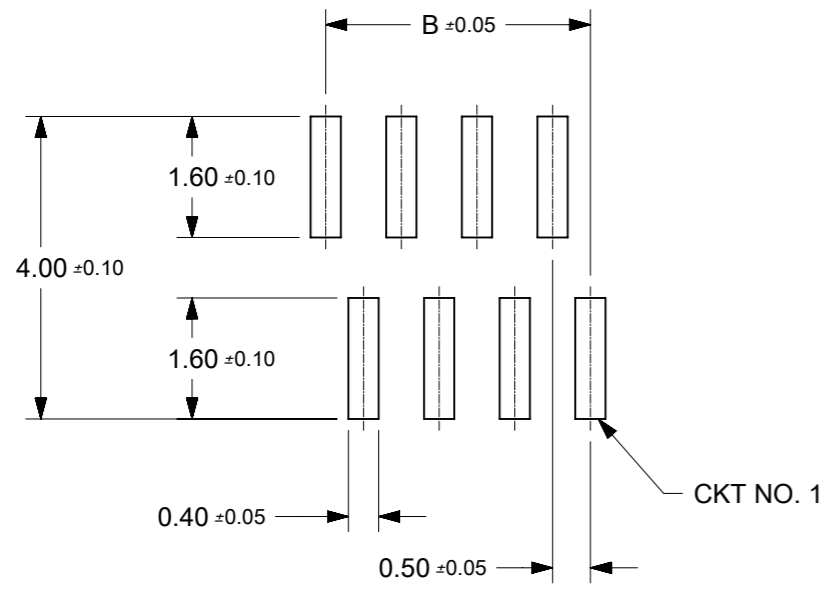

RECOMMENDED PCB LAYOUT

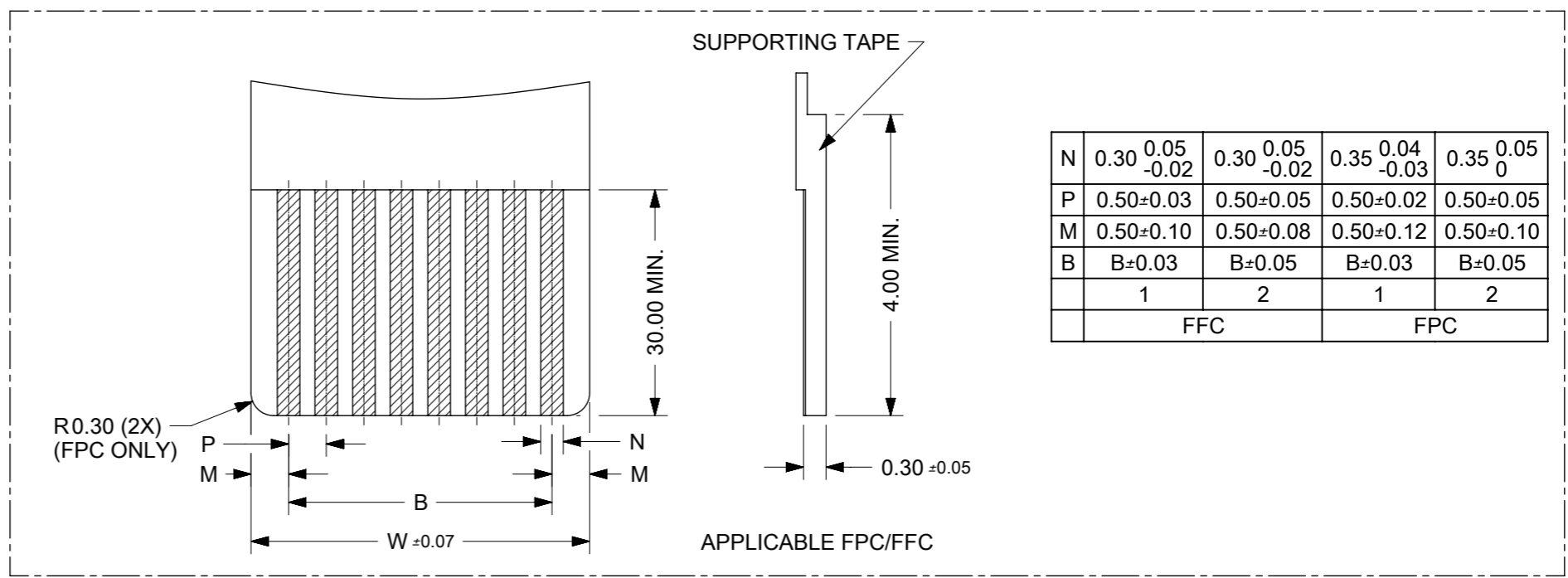

N	0.30 <sup>0.05</sup> <sub>-0.02</sub>	0.30 <sup>0.05</sup> <sub>-0.02</sub>	0.35 <sup>0.04</sup> <sub>-0.03</sub>	0.35 <sup>0.05</sup> <sub>0</sub>
P	0.50±0.03	0.50±0.05	0.50±0.02	0.50±0.05
M	0.50±0.10	0.50±0.08	0.50±0.12	0.50±0.10
B	B±0.03	B±0.05	B±0.03	B±0.05
	1	2	1	2
	FFC		FPC	



THIS DRAWING CONTAINS INFORMATION THAT IS PROPRIETARY TO MOLEX ELECTRONIC TECHNOLOGIES, LLC AND SHOULD NOT BE USED WITHOUT WRITTEN PERMISSION

DIMENSION UNITS	SCALE	CURRENT REV DESC: OBSOLETE PART NO		<b>molex</b>		
mm	NTS					
GENERAL TOLERANCES (UNLESS SPECIFIED)		EC NO: 629832		0.50MM PITCH, FPC CONN. NON-ZIF, SMT		
ANGULAR TOL	± 3.0°	DRWN: PKH	2019/12/10	PRODUCT CUSTOMER DRAWING		
4 PLACES	±	CHK'D: GGA	2020/01/22	DOCUMENT NUMBER		
3 PLACES	±	APPR: GGA	2020/01/22	SD-78119-001		DOC TYPE
2 PLACES	± 0.15	INITIAL REVISION:		DOC PART	001	REVISION
1 PLACE	±	DRWN: YLQIAO	2006/04/11	B		
0 PLACES	±	APPR: PTLIM	2006/04/18	SHEET NUMBER		
DRAFT WHERE APPLICABLE MUST REMAIN WITHIN DIMENSIONS		THIRD ANGLE PROJECTION	DRAWING	SERIES	MATERIAL NUMBER	CUSTOMER
			A3-SIZE	78119	SEE TABLE	GENERAL MARKET
DOCUMENT STATUS		P1	RELEASE DATE	2020/01/22	02:37:39	2 OF 5

PARTIAL GOLD PLATING TERMINAL ASSEMBLY PART NUMBERS

ASSY P/N W/O PACKAGING	CKT	DIM A	DIM B	DIM C	DIM D	PLATING TYPE
78119-0108	10	7.10	4.50	6.40	5.60	1
78119-0118	11	7.60	5.00	6.90	6.10	
78119-0128	12	8.10	5.50	7.40	6.60	
78119-0138	13	8.60	6.00	7.90	7.10	
78119-0148	14	9.10	6.50	8.40	7.60	
78119-0158	15	9.60	7.00	8.90	8.10	
78119-0168	16	10.10	7.50	9.40	8.60	
78119-0178	17	10.60	8.00	9.90	9.10	
78119-0188	18	11.10	8.50	10.40	9.60	
78119-0198	19	11.60	9.00	10.90	10.10	
78119-0208	20	12.10	9.50	11.40	10.60	
78119-0218	21	12.60	10.00	11.90	11.10	
78119-0228	22	13.10	10.50	12.40	11.60	
78119-0238	23	13.60	11.00	12.90	12.10	
78119-0248	24	14.10	11.50	13.40	12.60	
78119-0258	25	14.60	12.00	13.90	13.10	
78119-0268	26	15.10	12.50	14.40	13.60	
78119-0278	27	15.60	13.00	14.90	14.10	
78119-0288	28	16.10	13.50	15.40	14.60	
78119-0298	29	16.60	14.00	15.90	15.10	
78119-0308	30	17.10	14.50	16.40	15.60	

ASSY P/N W/O PACKAGING	CKT	DIM A	DIM B	DIM C	DIM D	PLATING TYPE
78119-0318	31	17.60	15.00	16.90	16.10	1
78119-0328	32	18.10	15.50	17.40	16.60	
78119-0338	33	18.60	16.00	17.90	17.10	
78119-0348	34	19.10	16.50	18.40	17.60	
78119-0358	35	19.60	17.00	18.90	18.10	
78119-0368	36	20.10	17.50	19.40	18.60	
78119-0378	37	20.60	18.00	19.90	19.10	
78119-0388	38	21.10	18.50	20.40	19.60	
78119-0398	39	21.60	19.00	20.90	20.10	
78119-0408	40	22.10	19.50	21.40	20.60	

THIS DRAWING CONTAINS INFORMATION THAT IS PROPRIETARY TO MOLEX ELECTRONIC TECHNOLOGIES, LLC AND SHOULD NOT BE USED WITHOUT WRITTEN PERMISSION									
DIMENSION UNITS	SCALE	CURRENT REV DESC: OBSOLETE PART NO							
mm	NTS								
GENERAL TOLERANCES (UNLESS SPECIFIED)		EC NO: 629832			0.50MM PITCH, FPC CONN. NON-ZIF, SMT				
ANGULAR TOL	± 3.0°	DRWN: PKH 2019/12/10							
4 PLACES	±	CHK'D: GGA 2020/01/22							
3 PLACES	±	APPR: GGA 2020/01/22			PRODUCT CUSTOMER DRAWING				
2 PLACES	± 0.15	INITIAL REVISION:			DOCUMENT NUMBER				
1 PLACE	±	DRWN: YLQIAO 2006/04/11			SD-78119-001				
0 PLACES	±	APPR: PTLIM 2006/04/18			DOC TYPE DOC PART REVISION				
DRAFT WHERE APPLICABLE MUST REMAIN WITHIN DIMENSIONS		THIRD ANGLE PROJECTION	DRAWING	SERIES	MATERIAL NUMBER	CUSTOMER	SHEET NUMBER		
			A3-SIZE	78119	SEE TABLE	GENERAL MARKET	3 OF 5		

TIN-BISMUTH PLATING TERMINAL ASSEMBLY PART NUMBERS

ASSY P/N W/O PACKAGING	CKT	DIM A	DIM B	DIM C	DIM D	PLATING TYPE
78119-0109	10	7.10	4.50	6.40	5.60	2
78119-0119	11	7.60	5.00	6.90	6.10	
78119-0129	12	8.10	5.50	7.40	6.60	
78119-0139	13	8.60	6.00	7.90	7.10	
78119-0149	14	9.10	6.50	8.40	7.60	
78119-0159	15	9.60	7.00	8.90	8.10	
78119-0169	16	10.10	7.50	9.40	8.60	
78119-0179	17	10.60	8.00	9.90	9.10	
78119-0189	18	11.10	8.50	10.40	9.60	
78119-0199	19	11.60	9.00	10.90	10.10	
78119-0209	20	12.10	9.50	11.40	10.60	
78119-0219	21	12.60	10.00	11.90	11.10	
78119-0229	22	13.10	10.50	12.40	11.60	
78119-0239	23	13.60	11.00	12.90	12.10	
78119-0249	24	14.10	11.50	13.40	12.60	
78119-0259	25	14.60	12.00	13.90	13.10	
78119-0269	26	15.10	12.50	14.40	13.60	
78119-0279	27	15.60	13.00	14.90	14.10	
78119-0289	28	16.10	13.50	15.40	14.60	
78119-0299	29	16.60	14.00	15.90	15.10	
78119-0309	30	17.10	14.50	16.40	15.60	

ASSY P/N W/O PACKAGING	CKT	DIM A	DIM B	DIM C	DIM D	PLATING TYPE
78119-0319	31	17.60	15.00	16.90	16.10	2
78119-0329	32	18.10	15.50	17.40	16.60	
78119-0339	33	18.60	16.00	17.90	17.10	
78119-0349	34	19.10	16.50	18.40	17.60	
78119-0359	35	19.60	17.00	18.90	18.10	
78119-0369	36	20.10	17.50	19.40	18.60	
78119-0379	37	20.60	18.00	19.90	19.10	
78119-0389	38	21.10	18.50	20.40	19.60	
78119-0399	39	21.60	19.00	20.90	20.10	
78119-0409	40	22.10	19.50	21.40	20.60	

THIS DRAWING CONTAINS INFORMATION THAT IS PROPRIETARY TO MOLEX ELECTRONIC TECHNOLOGIES, LLC AND SHOULD NOT BE USED WITHOUT WRITTEN PERMISSION									
DIMENSION UNITS	SCALE	CURRENT REV DESC: OBSOLETE PART NO							
mm	NTS								
GENERAL TOLERANCES (UNLESS SPECIFIED)		EC NO: 629832			0.50MM PITCH, FPC CONN. NON-ZIF, SMT				
ANGULAR TOL ± 3.0°		DRWN: PKH 2019/12/10							
4 PLACES ±		CHK'D: GGA 2020/01/22							
3 PLACES ±		APPR: GGA 2020/01/22			PRODUCT CUSTOMER DRAWING				
2 PLACES ± 0.15		INITIAL REVISION:			DOCUMENT NUMBER		DOC TYPE	DOC PART	REVISION
1 PLACE ±		DRWN: YLQIAO 2006/04/11			SD-78119-001		PSD	001	B
0 PLACES ±		APPR: PTLIM 2006/04/18			MATERIAL NUMBER		CUSTOMER		SHEET NUMBER
DRAFT WHERE APPLICABLE MUST REMAIN WITHIN DIMENSIONS		THIRD ANGLE PROJECTION	DRAWING	SERIES	SEE TABLE		GENERAL MARKET		4 OF 5

EMBOSSED TYPE B

EMBOSSED TYPE A

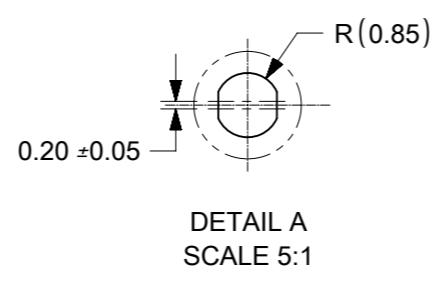
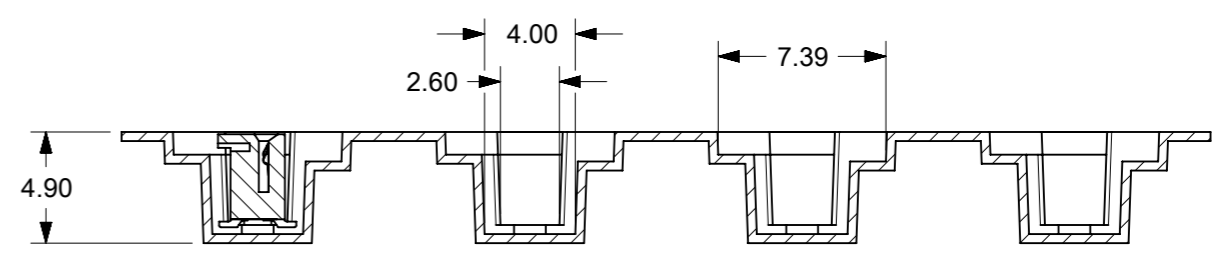
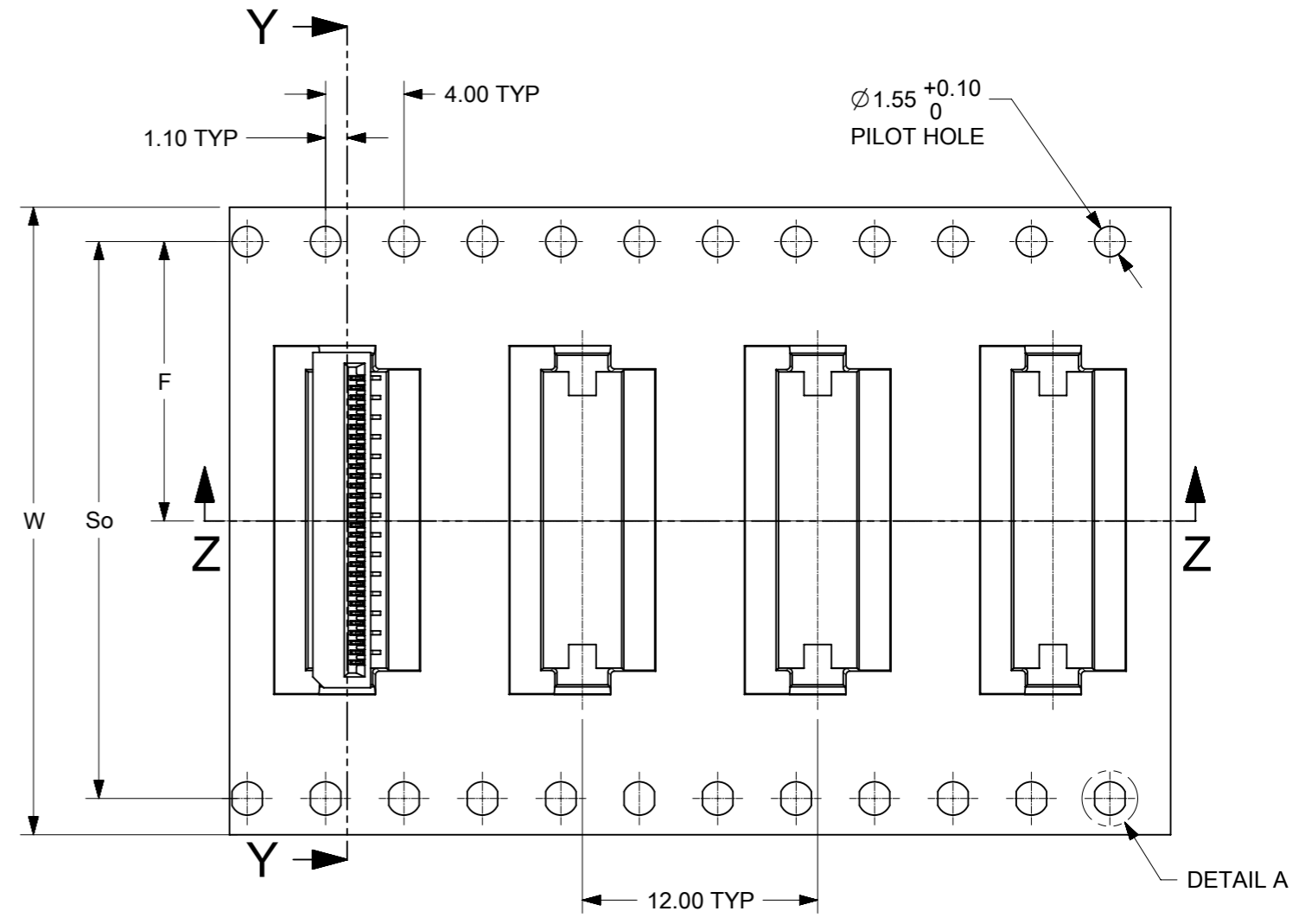
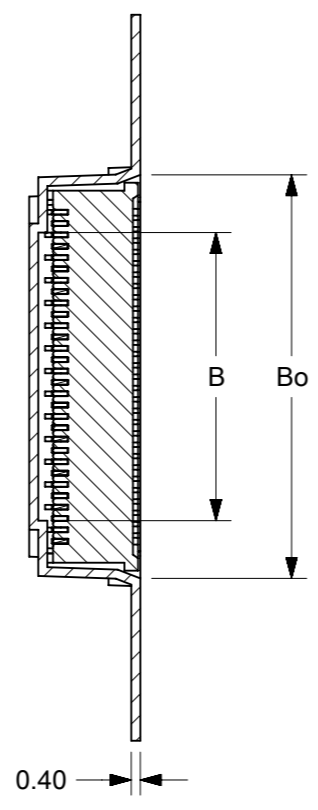
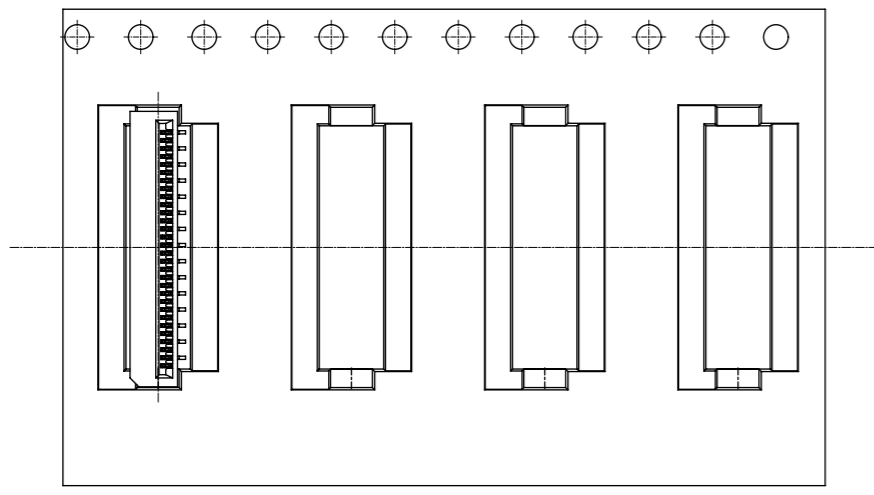

CUSTOMER PULL OUT DIRECTION

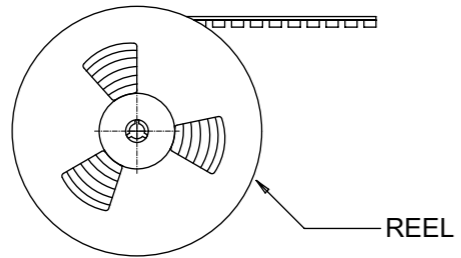

NOTES:

1. LEADER AND TRAILER TAPE

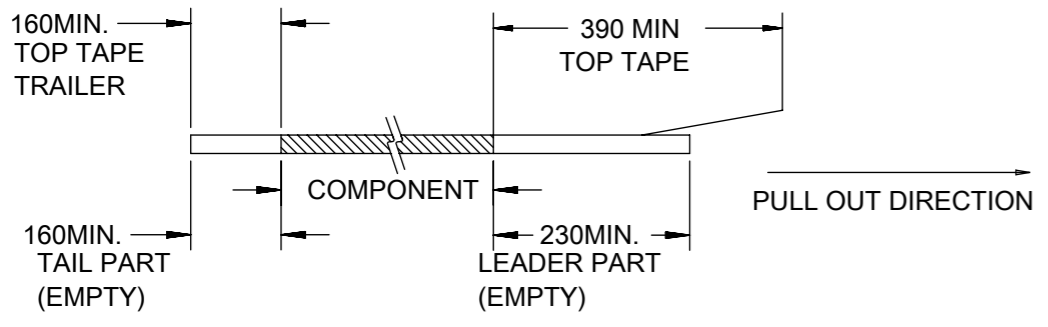

2. PEELING OFF FORCE OF THE TOP TAPE: 20-80gf.  
(PEELING DIRECTION AS SHOWN IN FOLLOWING FIGURE)

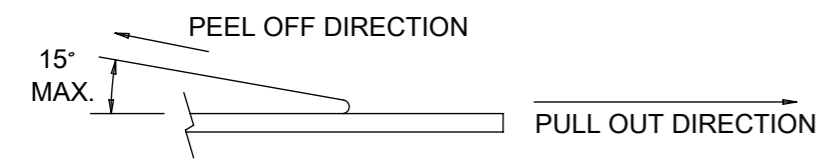

3. PACKAGING STANDARD IS AS PER EIA-481.  
4. TAPE & REEL QUANTITY = 1000 PCS/REEL

THIS DRAWING CONTAINS INFORMATION THAT IS PROPRIETARY TO MOLEX ELECTRONIC TECHNOLOGIES, LLC AND SHOULD NOT BE USED WITHOUT WRITTEN PERMISSION		CURRENT REV DESC: OBSOLETE PART NO		<b>molex</b>	
DIMENSION UNITS	SCALE				
mm	NTS			0.50MM PITCH, FPC CONN. NON-ZIF, SMT	
GENERAL TOLERANCES (UNLESS SPECIFIED)		EC NO: 629832		PRODUCT CUSTOMER DRAWING	
ANGULAR TOL	± 3.0°	DRWN: PKH	2019/12/10	DOCUMENT NUMBER	
4 PLACES	±	CHK'D: GGA	2020/01/22	SD-78119-001	
3 PLACES	±	APPR: GGA	2020/01/22	DOC TYPE	DOC PART
2 PLACES	± 0.15	INITIAL REVISION:		PSD	001
1 PLACE	±	DRWN: YLQIAO	2006/04/11	REVISION	
0 PLACES	±	APPR: PTLIM	2006/04/18	B	
DRAFT WHERE APPLICABLE MUST REMAIN WITHIN DIMENSIONS		THIRD ANGLE PROJECTION	DRAWING	SERIES	MATERIAL NUMBER
			A3-SIZE	78119	SEE TABLE
					CUSTOMER
					GENERAL MARKET
					SHEET NUMBER
					5 OF 5